

Digital Microscope 246 249

Users Manual (metal stand)

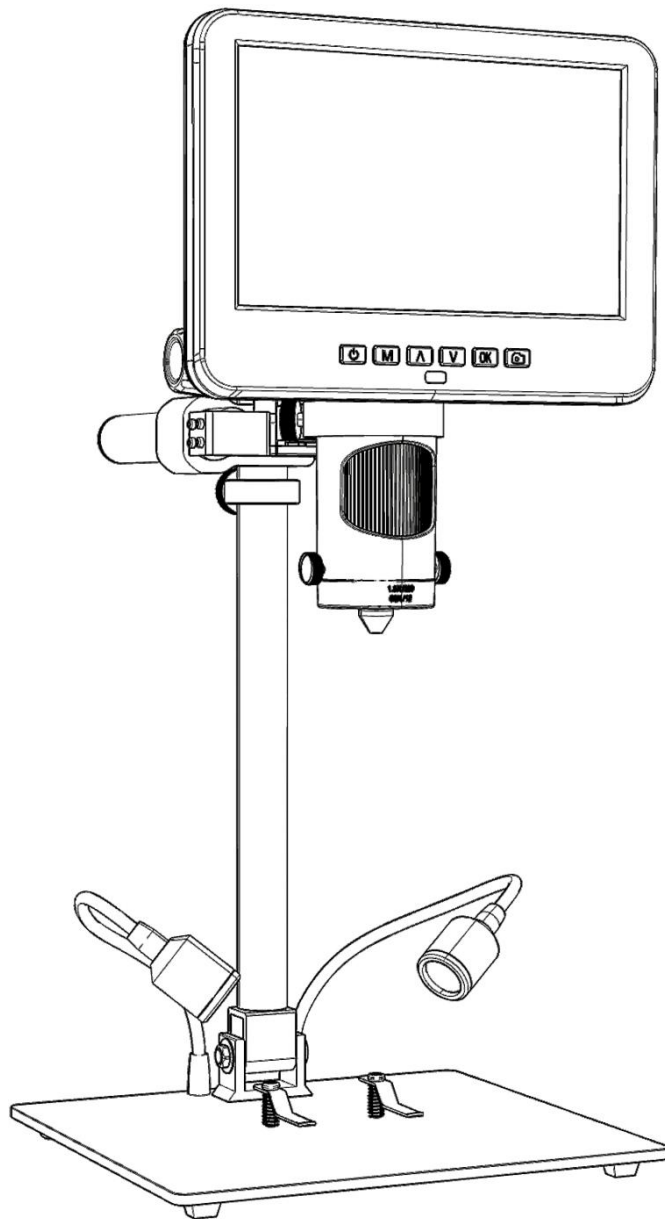

CONTENTS

Safety and maintenance	2
Specifications	2
Package include	3
Video demonstration	3
Buttons&Connection	4
Bracket installation	4
Bracket instructions	5
Quick Start	5
How to choose lens	6
Digital zoom	10
Save files to micro SD card	10
Remote	11
Settings	12
Trouble shooting	12
Warranty	13

Safety and maintenance

1. Please read this users manual carefully before using the device. It may cause permanent damage to the device to not follow the operation guide listed in this manual.
2. This product contains tiny parts and components that are NOT edible. Please let children and teens use this device under proper guide and supervise by adults. Disables, patients and people with allergy should not use this product.
3. We do not recommend using this product outdoor. It is not waterproof, and can not be placed in extreme environment: heat, high pressure etc.. Please keep and use it in safe, clean and dry environment. Stay it away from oil, gas, water and corrosive potions. Storage method refers to other electronic products, such as a computer.
4. Clean the lens when image goes blurry: cut the power supply firstly, wipe the lens with a soft clean cloth moistened with alcohol, make sure the whole device is dry before power it on again. Users should follow these steps for daily cleaning as well, remember to ONLY wipe the INSULATED part of the monitor.
5. The screen of the monitor is very fragile, please use it with care. Do not drop, hard press or leave it with sharp object. Hold the frame of the monitor to adjust its orientation. The monitor is not waterproof, please clean it with soft and dry material.
6. Please be aware that this microscope is not for medical use.

Specifications

Video resolution	FHD1920X1080 30FPS; 1080P 1440X1080 30FPS; 720P 1280X720 30FPS,
Video Format	AVI
Frame rate	Max 30fps
Magnification ratio	Lens A: 4.5-180x; Lens D: 450-510x; Lens L: 15-60x (with3 times digital zoom)
Working Distance	Lens A: 12mm-320mm; Lens D: 4mm- 5mm; Lens L: 90mm-300mm
Photo resolution	Max 4032*3024 (12M)
Photo Format	JPG
Storage	Micro-SD card, up to 32G (not included)
Power supply	5V 2A and above
Stand size	20cm*18cm*33cm
Package include	Microscope, Metal stand, 3 Lenses(A,D&L), Slide holder, Remote, Dimmer cable, Slides kit, Tweezers, Bug box

Package include

(P1 Package include)

- ① Microscope
- ② Metal bracket
- ③ Lens A (has been fixed)
- ④ Lens D
- ⑤ Lens L
- ⑥ Remote
- ⑦ Dimmer cable
- ⑧ Slide holder
- ⑨ Slides kit
- ⑩ Tweezers
- ⑪ Bug box



(P1 Package include)

Video demonstration:

Please find the video demo from the link (Please type all letters properly capitalized)/QR code below,

① Product installation:

<https://bit.ly/3rg8lTV>

② How to choose different lens:

<https://bit.ly/3J2r0bN>

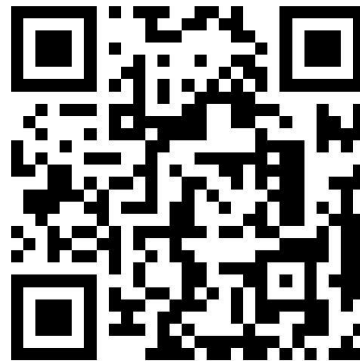

Buttons&Connection

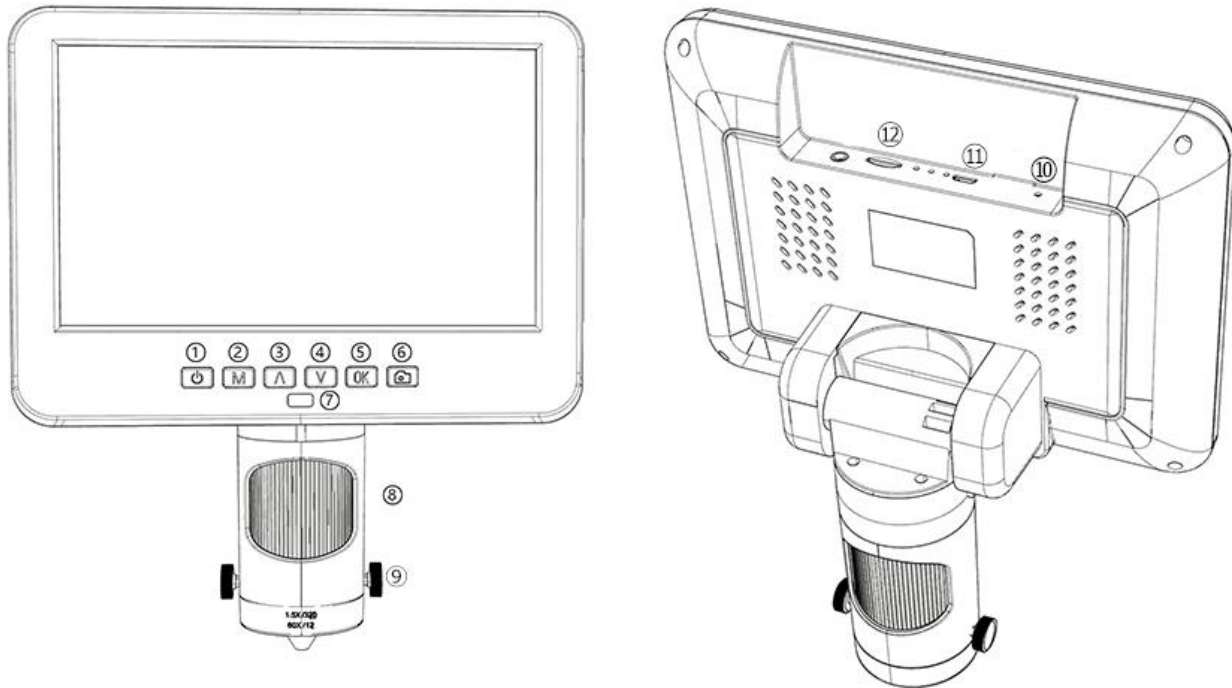

(P2 Buttons&Connection)

- | | | |
|------------------------|--|---------------------|
| ①Power on/off | ⑥Take pictures
(while the device is recording) | ⑨Lens fixing screws |
| ②Mode/Menu | ⑦Remote signal receiver
(where you aim remote to) | ⑩Reset |
| ③Up/Digital zoom in | | ⑪USB port |
| ④Down/Digital zoom out | | ⑫SD card slot |
| ⑤OK/Start recording | ⑧Focusing tube | |

Bracket installation

Please see the attached installation diagram.

Bracket instructions

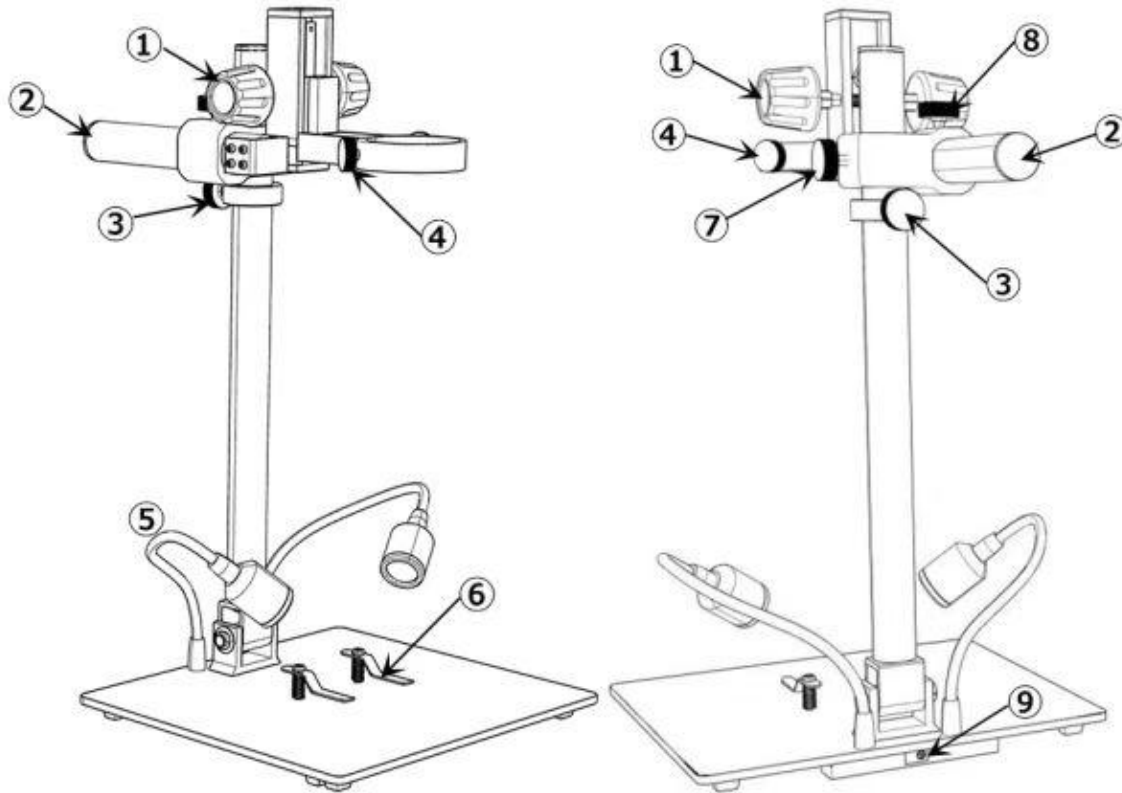

(P3 Bracket instructions)

- ① Secondary Bracket Lift
- ② Boom Arm
- ③ Lower Limit Stop
- ④ Monitor Fixing Screws
- ⑤ Spot Lights
- ⑥ Clips

- ⑦ Boom Arm V-locker(lock the arm in vertical direction)
- ⑧ Boom Arm H-locker(lock the arm in horizontal direction)
- ⑨ Spot Lights Interface

Quick Start

1. Connect the device to power supply as followed pic 4 to power on the microscope.
2. Press and hold the Power button (pic 2 # ①) until the monitor lights up. (device may switch on automatically when you power it on, and its totally normal)

*Trouble shooting

When the monitor image stops or froze, please pin the Reset hole (pic 2 #⑩) to reset the device first, then power on the device again. (Reset hole is very tiny, located at the back of the monitor. You may need to use the help of other tools with this process. All settings of the microscope will be back to factory setting after this, but it won' t delete any files saved in memory card).

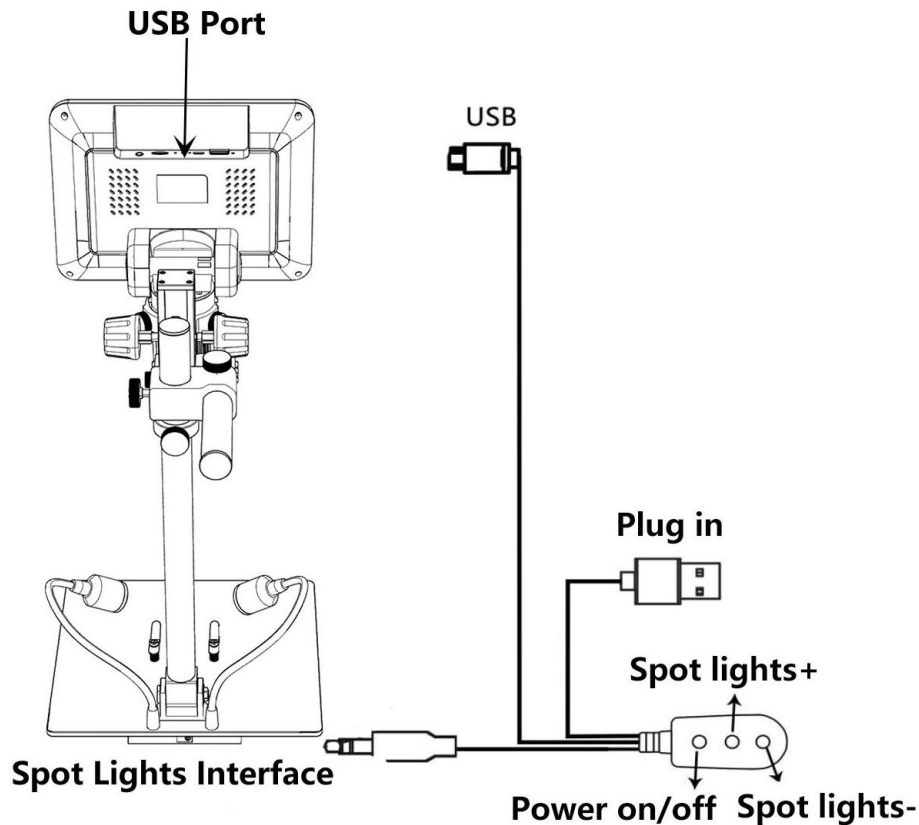

(pic 4 Connection)

How to choose lens

Lens L:

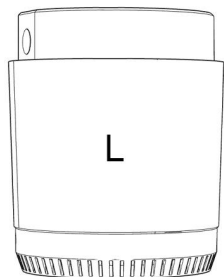

Working distance: 90mm-300mm,
Magnification: 15-60x (with 3 times digital zoom)
Applications: circuit board observe, watch repair etc.

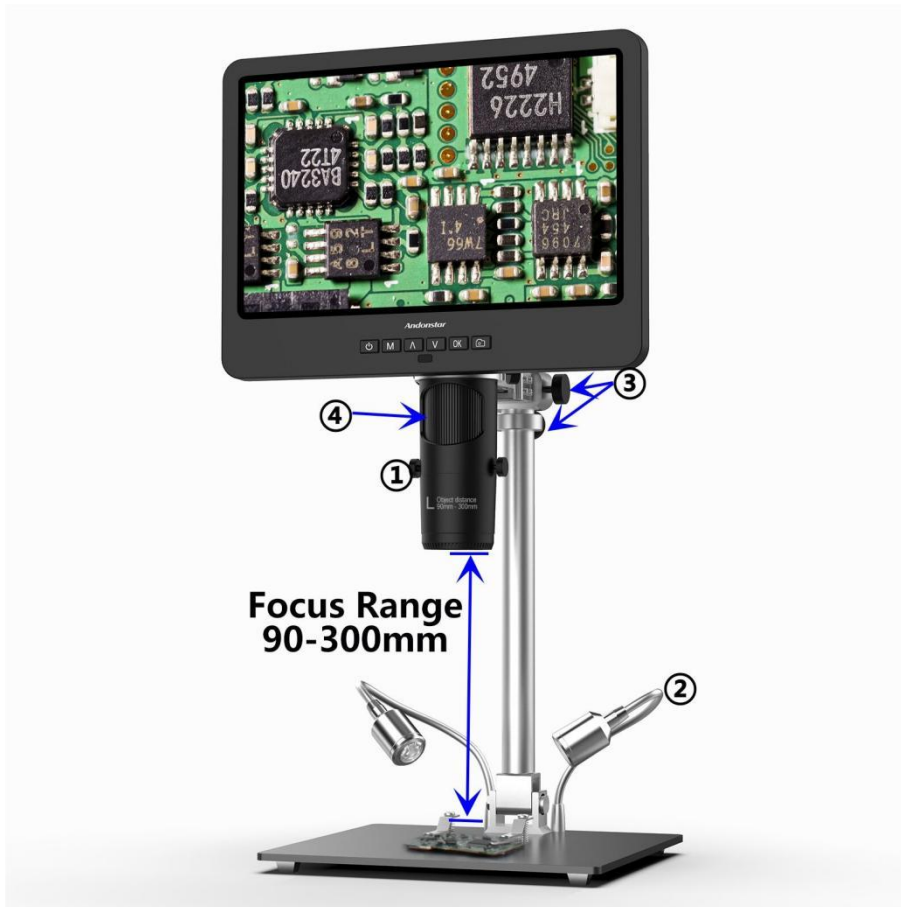

(pic 5 Go with lens L)

Steps: In pic 5 it marked out which parts of the microscope are involved to each step.

- ① Install and fix lens L to the bottom of the focusing tube.
- ② Bend the two goose-neck spot lights, make the field of view enough illuminated.
- ③ Loose the Arm V-locker, locate the whole monitor part to a desire height (distance from the lens to the specimen should be around 90mm to 300mm), then fix the V-locker. In order to adjust object distance more precisely, adjust the height of the secondary bracket. The shorter the object distance is, the bigger magnification is.
- ④ Turn the focusing tube to get a clear image. Turn it clockwise to zoom in and the other way to zoom out.

Lens A:

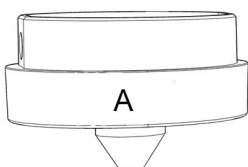

Working distance: 12mm-320mm,

Magnification: 4.5-180x (with 3 times digital zoom)

Applications: observe whole size or part of coins, stones/stamps collect, circuit board observe etc.



(pic 6 Go with Lens A)

Steps: In pic 6 it marked out which parts of the microscope are involved to each step.

- ① Install and fix lens A to the bottom of the focusing tube.
- ② Bend the two goose-neck spot lights, make sure the light shines on the coin.
- ③ Loose the Arm V-locker, locate the whole monitor part to a desire height (distance from the lens to the specimen should be around 12mm to 320mm), then fix the V-locker. In order to adjust object distance more precisely, adjust the height of the secondary bracket. The shorter the object distance is, the bigger magnification is.
- ④ Turn the focusing tube to get a clear image. Turn it clockwise to zoom in and the other way to zoom out.

*In order to observe part of the coin, please lower the arm height to shorten the object distance, then turn the focusing tube, get a clear image.

*Steps above can also be applied to observe plants, stones etc.

Lens D:

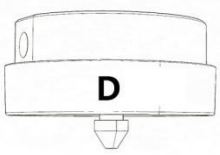

Working distance: 4mm-5mm,
Magnification: 450-510x (with 3 times digital zoom)
Applications: Microscope slides etc.

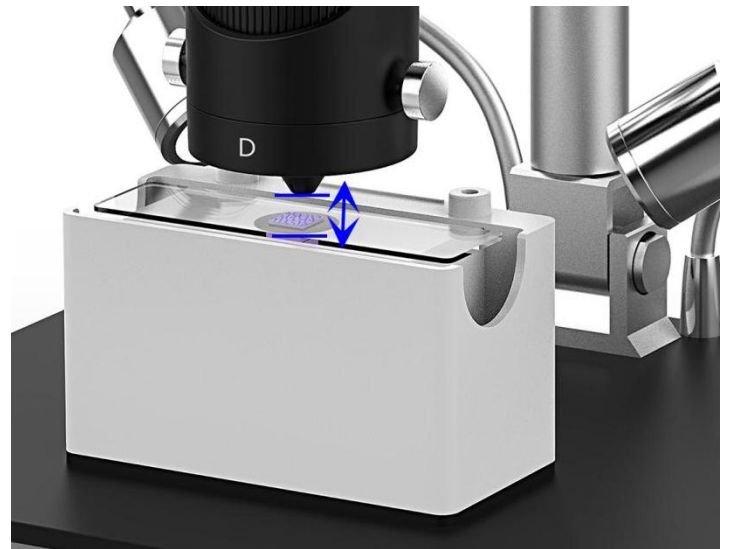
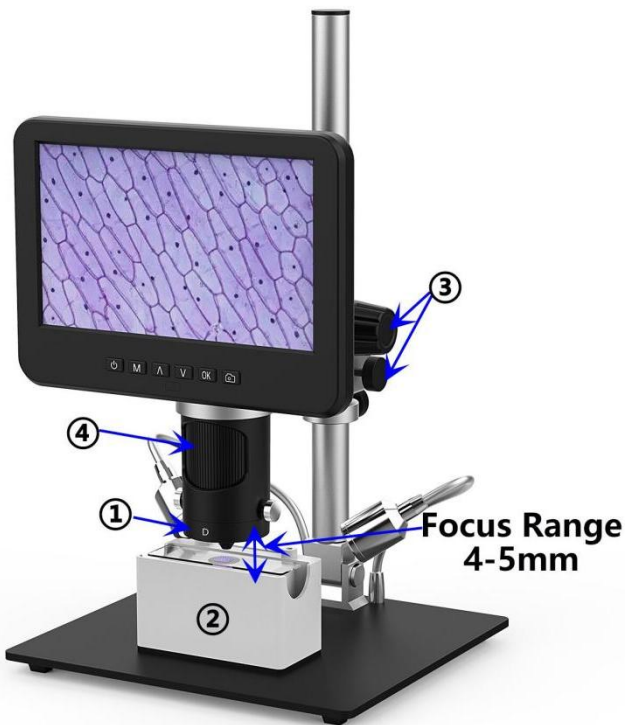

(Pic 7 Go with lens D)

Steps: In pic 7 it marked out which parts of the microscope are involved to each step.

- ① Install and fix lens D to the bottom of the focusing tube.
- ② Place a slide on the slides holder and power on the slides holder. (goose-neck spot lights can not provide proper illumination in this case, so leave them and use the same interface to power on slides holder)
- ③ Loose the Arm V-locker, locate the whole monitor part to a desire height (distance from the lens to the specimen should be around 4mm to 5mm), then fix the V-locker. Since the focus range is very short in this case, we recommend users to adjust the height of the secondary bracket instead, which is more precisely. The shorter the object distance is, the bigger magnification is.
- ④ Turn the focusing tube to get a clear image. Turn it clockwise to zoom in and the other way to zoom out.

***Lens D' s magnification is quite big, which requires a short object distance. Meanwhile, any tiny movement or shake of specimen would be displayed as huge on the monitor, which requires user to operate very carefully and patiently.**

Digital zoom

Press “up” button on the monitor(pic 2 #③) to apply digital zoom in, and “down” to zoom out(pic 2# ④)

Save files to micro SD card

To save images and videos to a memory card, please insert a card into the TF slot at the back of the monitor before power on the device.

Attention:

1. TD card are not included in the standard package. Please purchase it from quality suppliers. We recommend 10 grade high speed TF card.
2. Metal strip side of the card faces outward.
3. Push the card deeply into the card slot until you hear a click sound. Otherwise it would bounce back.
- 4. When the monitor shows “card error” or “card is full” , please format the card first before take pics. Format steps are: Press and hold button M until it shows a menu→press M button again to get into Setting menu→Press up or down button to select→choose” Format” and confirm**

MODE button (pic 4 #②, marked as “M”) can be used to selected among three modes, vid□□(), photo(📷) and playback(⏮). In video mode, on the right upper corner of the monitor shows time and “1080FHD” (white font). Time here shows how long a video the memory card is capable to record, and “1080FHD” shows the current video resolution.

Record videos

In video mode(□□), press OK button to start recording. Press it again to stop.
It works the same way with the OK button on the remote.

Take photos

In Photo mode(📷), press “OK” button to take pictures.

The button marked as a camera on (pic 2 #⑥), can also take pictures, but only while the camera is recording videos.

*** In playback mode the microscope can not take photos or videos**

Playback & manage files

Use button M to get into Playback mode, press “up” or “down” to browse files.

In order to play videos, press OK to play it, OK to pause, M to stop.

Remote

*Freeze: Stop the image on the display, works in video mode, photo mode and while recording.

*Illumination+ & -: exposure compensation from +2.0 to -2.0.

*Sharpness up&down: three levels of sharpness: Soft/Normal/Strong. Those two buttons are both used to switch the levels, but in different orders.

*Contrast up&down: same principle as Sharpness

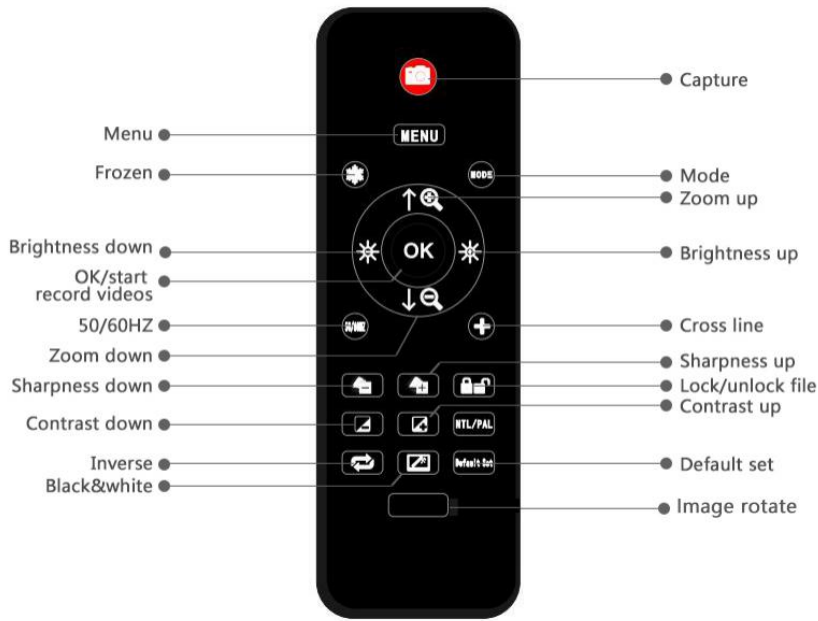

(Pic 8 Remote)

*Upside down: refer to pic as follow

Normal



Upside down



*Inverse: refer to pic as follow

Normal

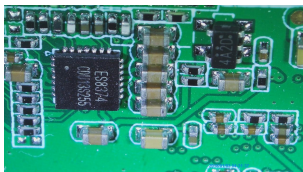

Inverse

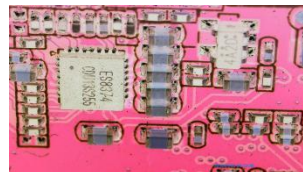

*Black&white: refer to pic as follow

Normal

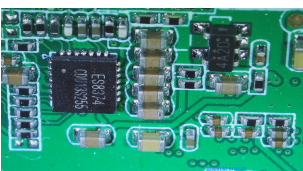

Black&white

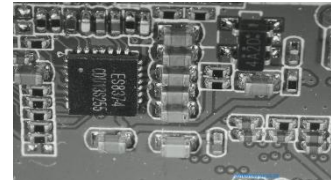

Settings

In any mode, press and hold M button until it shows video/photo/playback menu, press M again, get into Setting menu.

For example. In video mode, press and hold M button, it would show video menu as pic 9:

And then, press M again to get into settings menu as pic 10:



(pic 9 video menu)

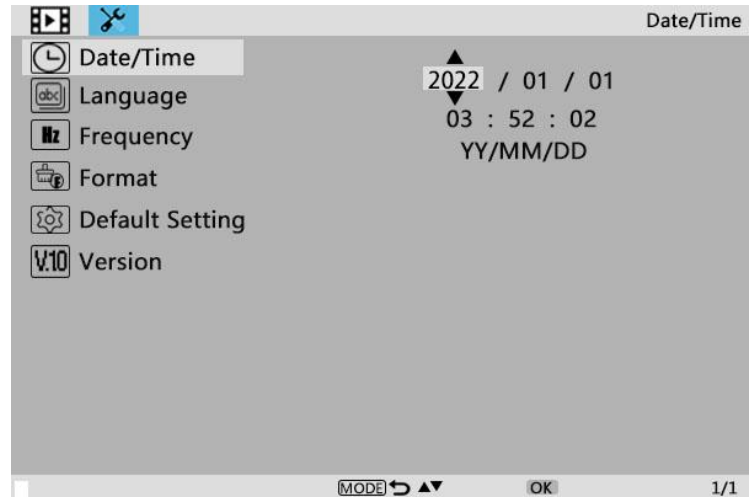

(pic 10 setting menu)

Date/Time Setting

Select "Date/Time" in setting menu, press OK button to get in time setting. Use "up" and "down" button to select correct number, OK to confirm and jump to the next one. After it's all done, press M to back to setting menu.

Save setting

In order to let the microscope memorize the setting changes, please turn off the microscope by PRESSING THE POWER BUTTON ON THE MONITOR (press and hold until it switch off).

Setting changes won't be saved if you switch off the device in other ways.

Trouble shooting

1.The microscope can't be switched on.

Please check the connection is exactly as pic 4 shows, power supply is strong enough (5V 2A & above) and stable. If the device still can be not switched on, please pin the reset hole at the back side of monitor.

2.Images are not clear.

Please confirm the illumination work properly, and shine directly to the surface of the specimen. Adjust the height of the boom arm, or the secondary bracket lift to change the distance from the lens to the specimen, and turn the focusing tube properly. If the image is still blurry, please clean the bottom of the lens use a piece of clean and soft cloth.

3. Setting changes can't be memorized.

After changing settings, press and hold the button on the monitor to switch off the device. DO NOT cut off the power supply directly or use the dimmer cable to switch off the device.

4. The microscope reboots repeatedly.

Please check if the cable connection is firm and if the power supply is stable and strong enough. Please check your power adapter is high quality 5V 2A.

4. It shows "card error" or "card is full" after inserting memory card to the device.

Please format the card after insert it into the device. (Format steps refer to chapter "Save files to micro SD card")

PS: If there are other questions or problems, please contact us as soon as possible, we will do our best to help! Thanks for your support!

Warranty

Warranty		
Name:	Address:	
Phone number:	Post code:	Email:
Model name:	Purchase date:	
Fault details:		
Date:	Fault description:	
Notice:		
Our warranty does not cover:		
1	If the purchaser can not provide a purchase proof, or it shows the product was bought as second hand condition	
2	If the product has been placed or used in an improper environment, such as heat, wet, wrong power supply environment etc.	
3	If the fault caused by accident, oversight, faulty operation or natural disasters etc.	
4	If the fault caused by people who are not belong to authorized organizations of our company during repacking, repair, dismantle, Or if users repack, repair or dismantle the device not following our advice.	
5	Out of warranty period.	